



VENETIAN BLINDS C80 GUIDES (CRANK OR MOTOR)

The C-type external venetian blind is a well-proven and the most popular kind of shading system. The universal nature of the system will prove itself both in homes and office buildings. It is also the most flexible solution, which may be applied different ways, depending on end users needs.



STANDARD CONSTRUCTION COLORS

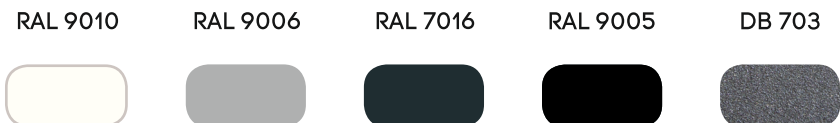

STANDARD SLAT COLORS

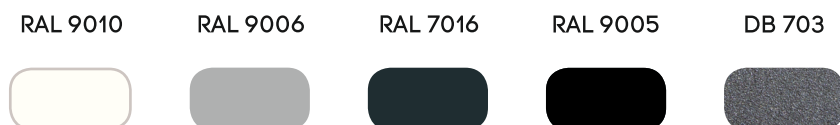

PRODUCT DIMENSIONS

MIN width: 800 mm	MIN height: 800 mm
MAX width: 4600 mm	MAX height: 4500 mm

DRIVE

- crank, standard length of 2/3 height of the venetian blind
- motor



COVER PANELS

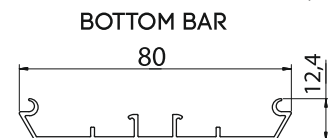
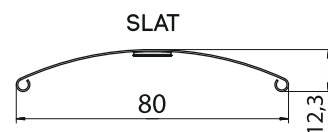
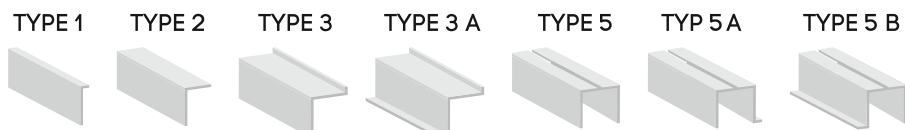

GUIDE

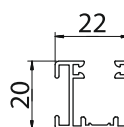

HEAD RAIL

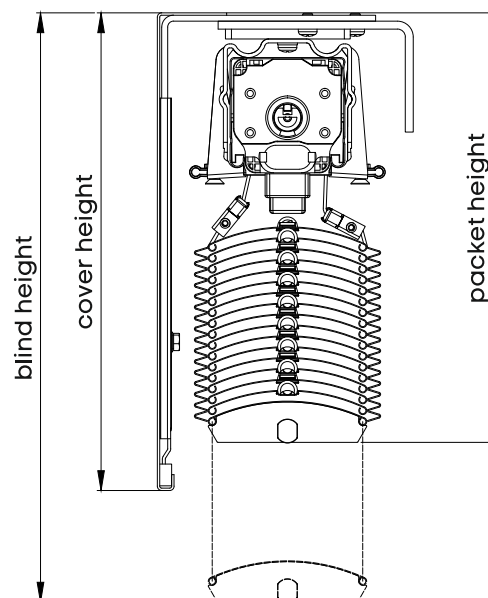
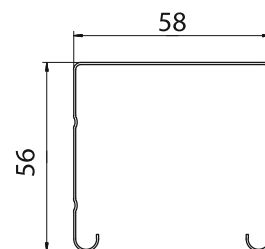

* The manufacturer reserves the right to change the construction of the products.

